



NEW LIGHTING COLLECTIONS



www.fedeswitchandlight.com

INDEX

TWENTY Flex Lamp collection	4
ROUND Flex Lamp collection	18
STUDIO Flex Lamp collection	30
ROUND Reading Lamp collection	38
TWENTY Reading Lamp collection	40
TULIPA Wall Light collection	42
Technical Data	46

New COLLECTIONS

Brass is back but now in its ultra slim version to integrate perfectly with your walls. We transform top-quality brass sheets into smart frames in trendy **MATT** finishes: white, black, satin matt nickel, satin matt gold and soft matt patina.

Less is more once again... Our craftsmen with their years of experience, artistic eye and incredible skills have created these original matt finishes to make your **décor unique**.

The timeless beauty and ability to be perfectly matched with any colour scheme means the new **Twenty, Studio & Round** light switch collections are a "must have" for your next interior design project.



MATT WHITE



SATIN
MATT GOLD

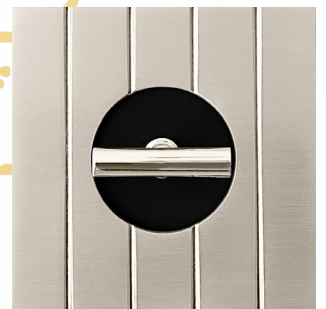

SATIN MATT NICKEL



SATIN
MATT PATINA



MATT BLACK



MATT WHITE



TWENTY

Flex Lamp collection



TWENTY

Flex Lamp collection

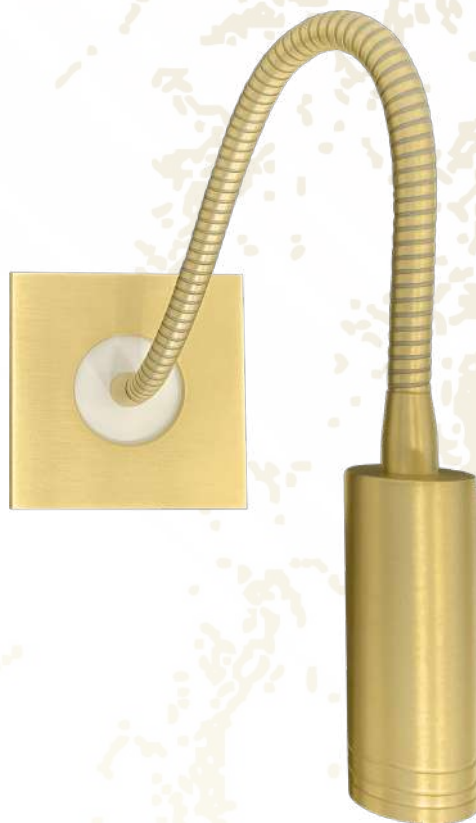

REFERENCE: FDF02001-1-2

This reading lamp is like a built-in mechanism, so you can install it in a standard built-in box next to the headboard. You can move it, to direct the light when you need it. It incorporates a 2.6W direct Bi-Pin G9 LED LAMP at 230V and a color temperature of 2700°K, to create a cozy atmosphere. It also includes a matt glass to maintain a good uniformity in the object to be illuminated, creating a great light effect.

We can choose single color or combine finishes:

SMN
Satin Matt Nickel



SMP
Soft Matt Patinated



SMG
Satin Matt Gold



WH



BK



OB



CB



CM



PB



PM

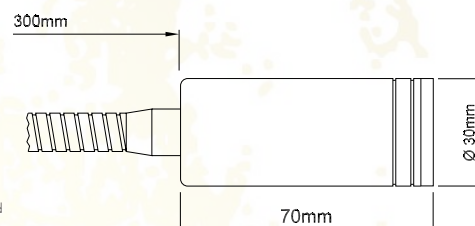

TWENTY

Flex Lamp collection



REFERENCE: FDF02001-1-2

This reading lamp is like a built-in mechanism, so you can install it in a standard built-in box next to the headboard. You can move it, to direct the light when you need it. It incorporates a 2.6W direct Bi-Pin G9 LED LAMP at 230V and a color temperature of 2700°K, to create a cozy atmosphere. It also includes a matt glass to maintain a good uniformity in the object to be illuminated, creating a great light effect.

We can choose single color or combine finishes:

SMN
Satin Matt Nickel



SMP
Soft Matt Patinated



SMG
Satin Matt Gold



WH
White



BK
Black



OB
Bright Gold



CB
Bright Chrome



CM
Matt Chrome



PB
Bright Patinated



PM
Matt Patinated

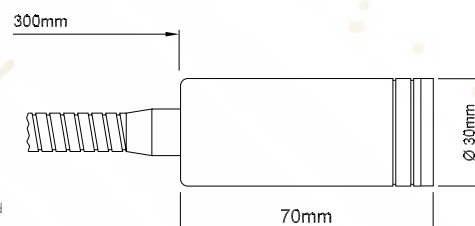

TWENTY

Flex Lamp collection



REFERENCE: FDF02001-1-2

This reading lamp is like a built-in mechanism, so you can install it in a standard built-in box next to the headboard. You can move it, to direct the light when you need it. It incorporates a 2.6W direct Bi-Pin G9 LED LAMP at 230V and a color temperature of 2700°K, to create a cozy atmosphere. It also includes a matt glass to maintain a good uniformity in the object to be illuminated, creating a great light effect.

We can choose single color or combine finishes:

SMN
Satin Matt Nickel



SMP
Soft Matt Patinated



SMG
Satin Matt Gold



WH
White



BK
Black



OB
Bright Gold



CB
Bright Chrome



CM
Matt Chrome



PB
Bright Patinated



PM
Matt Patinated

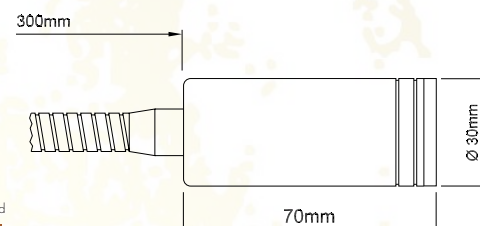

TWENTY

Flex Lamp collection

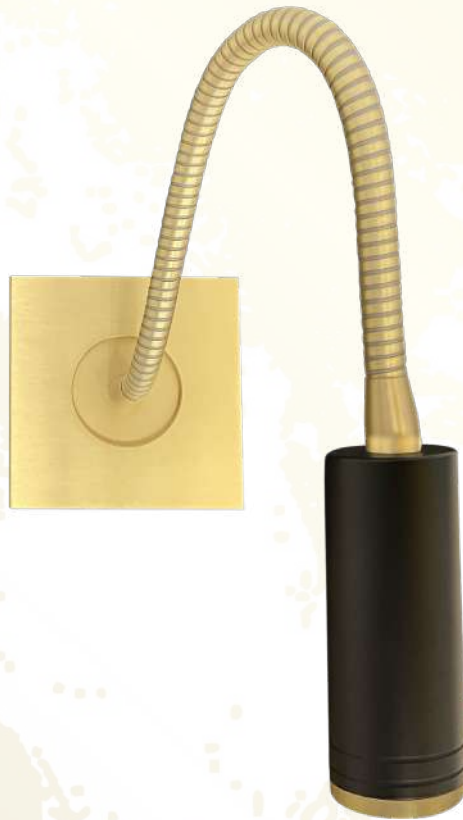

REFERENCE: FDF02001-1-2

This reading lamp is like a built-in mechanism, so you can install it in a standard built-in box next to the headboard. You can move it, to direct the light when you need it. It incorporates a 2.6W direct Bi-Pin G9 LED LAMP at 230V and a color temperature of 2700°K, to create a cozy atmosphere. It also includes a matt glass to maintain a good uniformity in the object to be illuminated, creating a great light effect.

We can choose single color or combine finishes:

SMN
Satin Matt Nickel



SMP
Soft Matt Patinated



SMG
Satin Matt Gold



WH
White



BK
Black



OB
Bright Gold



CB
Bright Chrome



CM
Matt Chrome



PB
Bright Patinated



PM
Matt Patinated

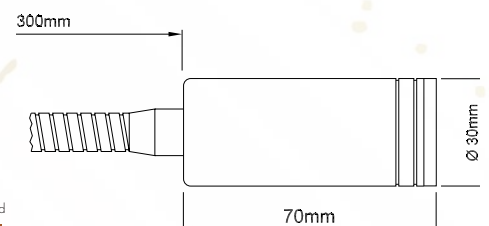

TWENTY

Flex Lamp collection



REFERENCE: FDF02001-1-2

This reading lamp is like a built-in mechanism, so you can install it in a standard built-in box next to the headboard. You can move it, to direct the light when you need it. It incorporates a 2.6W direct Bi-Pin G9 LED LAMP at 230V and a color temperature of 2700°K, to create a cozy atmosphere. It also includes a matt glass to maintain a good uniformity in the object to be illuminated, creating a great light effect.

We can choose single color or combine finishes:

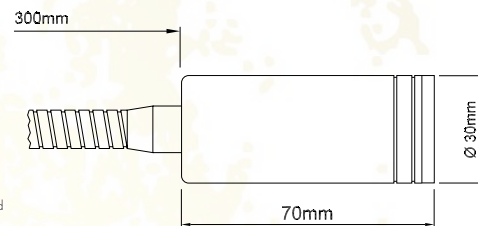
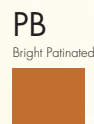

TWENTY

Flex Lamp collection

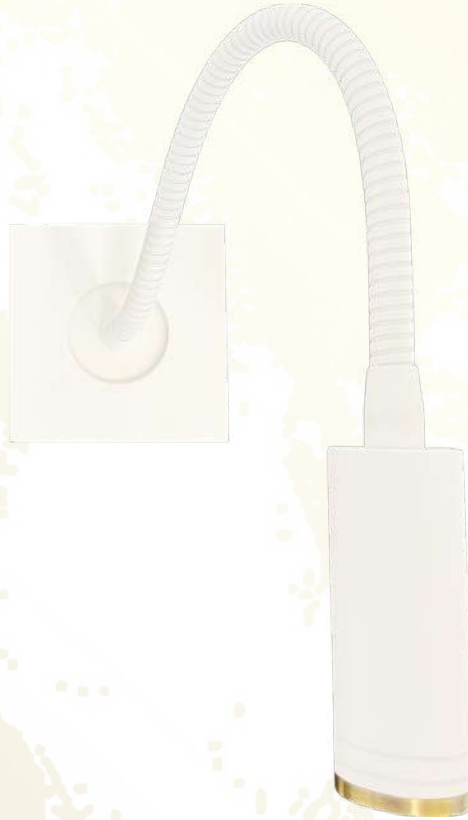

REFERENCE: FDF02001-1-2

This reading lamp is like a built-in mechanism, so you can install it in a standard built-in box next to the headboard. You can move it, to direct the light when you need it. It incorporates a 2.6W direct Bi-Pin G9 LED LAMP at 230V and a color temperature of 2700°K, to create a cozy atmosphere. It also includes a matt glass to maintain a good uniformity in the object to be illuminated, creating a great light effect.

We can choose single color or combine finishes:

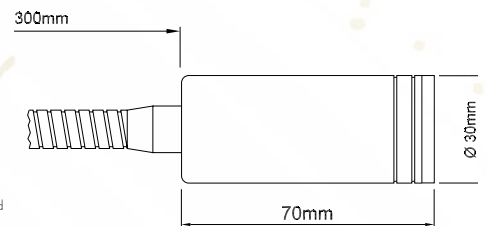
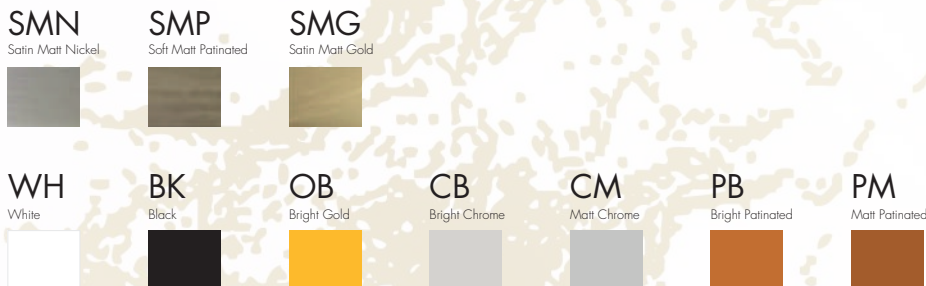

TWENTY

Flex Lamp collection



REFERENCE: FDF02001-1-3

This reading lamp is like a built-in mechanism, so you can install it in a standard built-in box next to the headboard. You can move it, to direct the light when you need it. It incorporates a 2.6W direct Bi-Pin G9 LED LAMP at 230V and a color temperature of 2700°K, to create a cozy atmosphere. It also includes a matt glass to maintain a good uniformity in the object to be illuminated, creating a great light effect.

We can choose single color or combine finishes:

SMN
Satin Matt Nickel



SMP
Soft Matt Patinated



SMG
Satin Matt Gold



WH

White



BK

Black



OB

Bright Gold



CB

Bright Chrome



CM

Matt Chrome



PB

Bright Patinated



PM

Matt Patinated

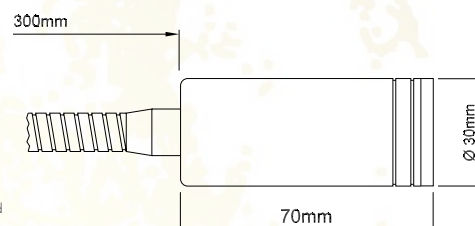

TWENTY

Flex Lamp collection



REFERENCE: FDF02001-1-2

This reading lamp is like a built-in mechanism, so you can install it in a standard built-in box next to the headboard. You can move it, to direct the light when you need it. It incorporates a 2.6W direct Bi-Pin G9 LED LAMP at 230V and a color temperature of 2700°K, to create a cozy atmosphere. It also includes a matt glass to maintain a good uniformity in the object to be illuminated, creating a great light effect.

We can choose single color or combine finishes:

SMN
Satin Matt Nickel



SMP
Soft Matt Patinated



SMG
Satin Matt Gold



WH
White



BK
Black



OB
Bright Gold



CB
Bright Chrome



CM
Matt Chrome



PB
Bright Patinated



PM
Matt Patinated

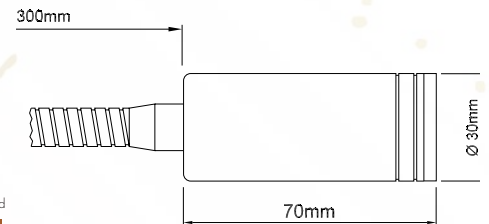

TWENTY

Flex Lamp collection



REFERENCE: FDF02001-1-2

This reading lamp is like a built-in mechanism, so you can install it in a standard built-in box next to the headboard. You can move it, to direct the light when you need it. It incorporates a 2.6W direct Bi-Pin G9 LED LAMP at 230V and a color temperature of 2700°K, to create a cozy atmosphere. It also includes a matt glass to maintain a good uniformity in the object to be illuminated, creating a great light effect.

We can choose single color or combine finishes:

SMN
Satin Matt Nickel



SMP
Soft Matt Patinated



SMG
Satin Matt Gold



WH

White



BK

Black



OB

Bright Gold



CB

Bright Chrome



CM

Matt Chrome



PB

Bright Patinated



PM

Matt Patinated

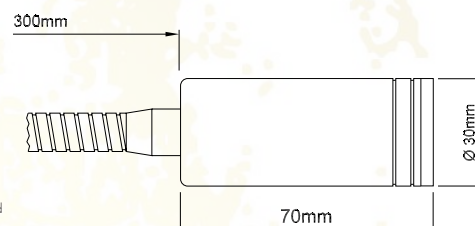

TWENTY

Flex Lamp collection



REFERENCE: FDF02001-1-2

This reading lamp is like a built-in mechanism, so you can install it in a standard built-in box next to the headboard. You can move it, to direct the light when you need it. It incorporates a 2.6W direct Bi-Pin G9 LED LAMP at 230V and a color temperature of 2700°K, to create a cozy atmosphere. It also includes a matt glass to maintain a good uniformity in the object to be illuminated, creating a great light effect.

We can choose single color or combine finishes:

SMN
Satin Matt Nickel



SMP
Soft Matt Patinated



SMG
Satin Matt Gold



WH
White



BK
Black



OB
Bright Gold



CB
Bright Chrome



CM
Matt Chrome



PB
Bright Patinated



PM
Matt Patinated

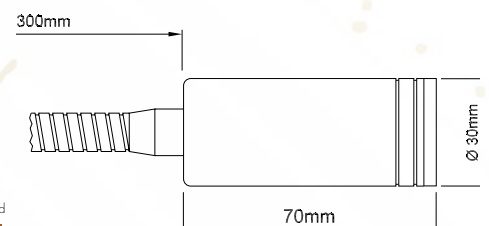

TWENTY

Flex Lamp collection



REFERENCE: FDF02001-1-2

This reading lamp is like a built-in mechanism, so you can install it in a standard built-in box next to the headboard. You can move it, to direct the light when you need it. It incorporates a 2.6W direct Bi-Pin G9 LED LAMP at 230V and a color temperature of 2700°K, to create a cozy atmosphere. It also includes a matt glass to maintain a good uniformity in the object to be illuminated, creating a great light effect.

We can choose single color or combine finishes:

SMN
Satin Matt Nickel



SMP
Soft Matt Patinated



SMG
Satin Matt Gold



WH

White



BK

Black



OB

Bright Gold



CB

Bright Chrome



CM

Matt Chrome



PB

Bright Patinated



PM

Matt Patinated



300mm

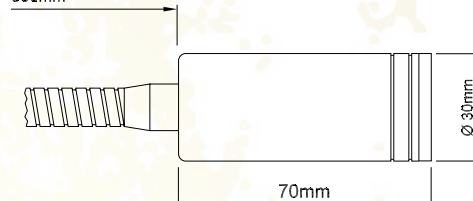

TWENTY

Flex Lamp collection



REFERENCE: FDF02001-1-3

This reading lamp is like a built-in mechanism, so you can install it in a standard built-in box next to the headboard. You can move it, to direct the light when you need it. It incorporates a 2.6W direct Bi-Pin G9 LED LAMP at 230V and a color temperature of 2700°K, to create a cozy atmosphere. It also includes a matt glass to maintain a good uniformity in the object to be illuminated, creating a great light effect.

We can choose single color or combine finishes:

SMN
Satin Matt Nickel



SMP
Soft Matt Patinated



SMG
Satin Matt Gold



WH

White



BK

Black



OB

Bright Gold



CB

Bright Chrome



CM

Matt Chrome



PB

Bright Patinated



PM

Matt Patinated

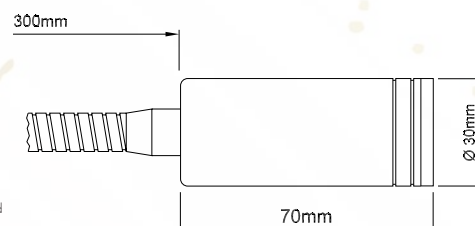

TWENTY

Flex Lamp collection



REFERENCE: FDF02001-1-2

This reading lamp is like a built-in mechanism, so you can install it in a standard built-in box next to the headboard. You can move it, to direct the light when you need it. It incorporates a 2.6W direct Bi-Pin G9 LED LAMP at 230V and a color temperature of 2700°K, to create a cozy atmosphere. It also includes a matt glass to maintain a good uniformity in the object to be illuminated, creating a great light effect.

We can choose single color or combine finishes:

SMN
Satin Matt Nickel



SMP
Soft Matt Patinated



SMG
Satin Matt Gold



WH

White



BK

Black



OB

Bright Gold



CB

Bright Chrome



CM

Matt Chrome



PB

Bright Patinated



PM

Matt Patinated

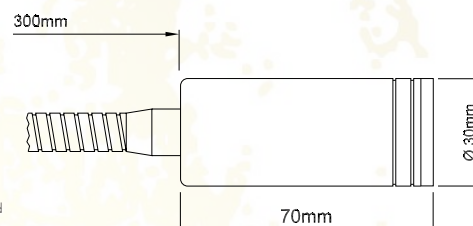

ROUND

Flex Lamp collection





ROUND

Flex Lamp collection



REFERENCE: FDF01901-1-2

This reading lamp is like a built-in mechanism, so you can install it in a standard built-in box next to the headboard. You can move it, to direct the light when you need it. It incorporates a 2.6W direct Bi-Pin G9 LED LAMP at 230V and a color temperature of 2700°K, to create a cozy atmosphere. It also includes a matt glass to maintain a good uniformity in the object to be illuminated, creating a great light effect.

We can choose single color or combine finishes:

SMN

Satin Matt Nickel



SMP

Soft Matt Patinated



SMG

Satin Matt Gold



WH

White



BK

Black



OB

Bright Gold



CB

Bright Chrome



CM

Matt Chrome



PB

Bright Patinated



PM

Matt Patinated



300mm

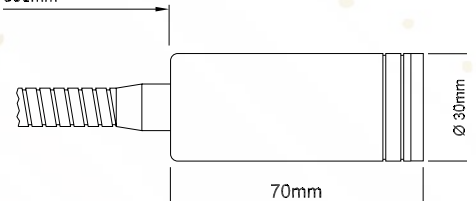

ROUND

Flex Lamp collection



REFERENCE: FDF01901-1-2

This reading lamp is like a built-in mechanism, so you can install it in a standard built-in box next to the headboard. You can move it, to direct the light when you need it. It incorporates a 2.6W direct Bi-Pin G9 LED LAMP at 230V and a color temperature of 2700°K, to create a cozy atmosphere. It also includes a matt glass to maintain a good uniformity in the object to be illuminated, creating a great light effect.

We can choose single color or combine finishes:

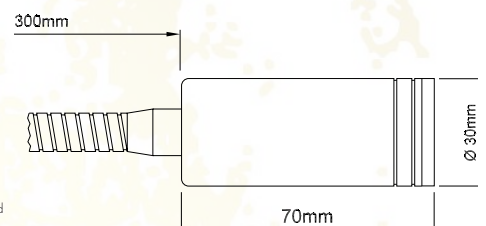

ROUND

Flex Lamp collection



REFERENCE: FDF01901-1-2

This reading lamp is like a built-in mechanism, so you can install it in a standard built-in box next to the headboard. You can move it, to direct the light when you need it. It incorporates a 2.6W direct Bi-Pin G9 LED LAMP at 230V and a color temperature of 2700°K, to create a cozy atmosphere. It also includes a matt glass to maintain a good uniformity in the object to be illuminated, creating a great light effect.

We can choose single color or combine finishes:

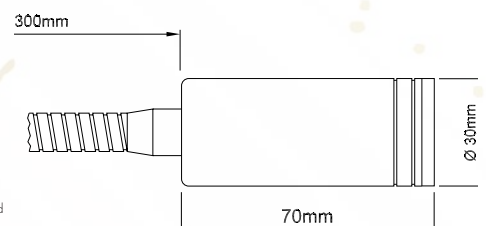

ROUND

Flex Lamp collection



REFERENCE: FDF01901-1-2

This reading lamp is like a built-in mechanism, so you can install it in a standard built-in box next to the headboard. You can move it, to direct the light when you need it. It incorporates a 2.6W direct Bi-Pin G9 LED LAMP at 230V and a color temperature of 2700°K, to create a cozy atmosphere. It also includes a matt glass to maintain a good uniformity in the object to be illuminated, creating a great light effect.

We can choose single color or combine finishes:

SMN
Satin Matt Nickel



SMP
Soft Matt Patinated



SMG
Satin Matt Gold



WH



BK



OB



CB



CM



PB



PM

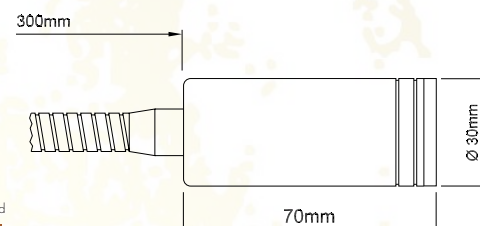

ROUND

Flex Lamp collection

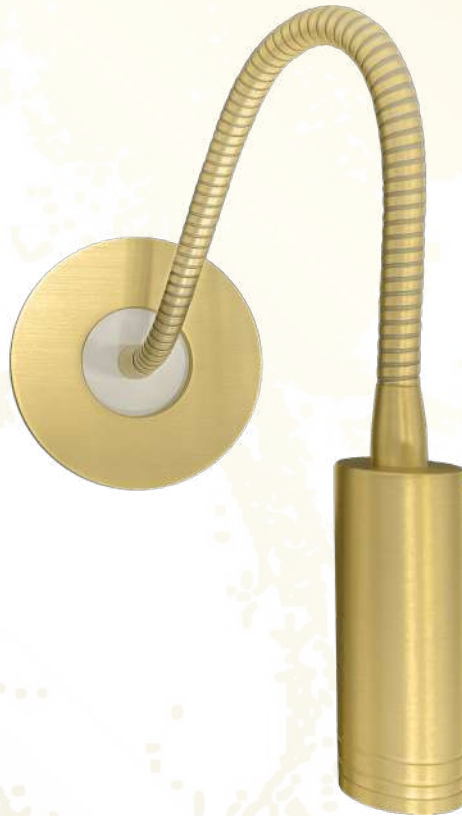

REFERENCE: FDF01901-1-2

This reading lamp is like a built-in mechanism, so you can install it in a standard built-in box next to the headboard. You can move it, to direct the light when you need it. It incorporates a 2.6W direct Bi-Pin G9 LED LAMP at 230V and a color temperature of 2700°K, to create a cozy atmosphere. It also includes a matt glass to maintain a good uniformity in the object to be illuminated, creating a great light effect.

We can choose single color or combine finishes:

SMN

Satin Matt Nickel



SMP

Soft Matt Patinated



SMG

Satin Matt Gold



WH

White



BK

Black



OB

Bright Gold



CB

Bright Chrome



CM

Matt Chrome



PB

Bright Patinated



PM

Matt Patinated



300mm

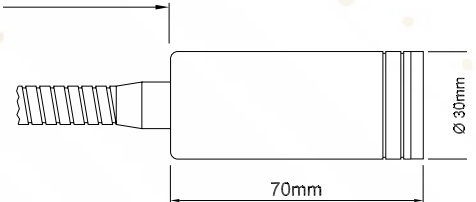

ROUND

Flex Lamp collection



REFERENCE: FDF01901-1-2

This reading lamp is like a built-in mechanism, so you can install it in a standard built-in box next to the headboard. You can move it, to direct the light when you need it. It incorporates a 2.6W direct Bi-Pin G9 LED LAMP at 230V and a color temperature of 2700°K, to create a cozy atmosphere. It also includes a matt glass to maintain a good uniformity in the object to be illuminated, creating a great light effect.

We can choose single color or combine finishes:

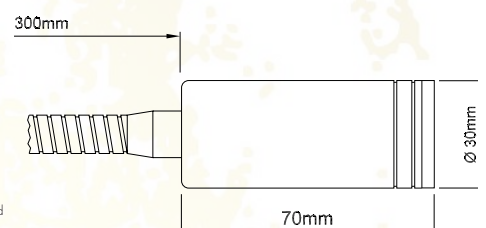
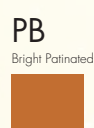

ROUND

Flex Lamp collection



REFERENCE: FDF01901-1-2

This reading lamp is like a built-in mechanism, so you can install it in a standard built-in box next to the headboard. You can move it, to direct the light when you need it. It incorporates a 2.6W direct Bi-Pin G9 LED LAMP at 230V and a color temperature of 2700°K, to create a cozy atmosphere. It also includes a matt glass to maintain a good uniformity in the object to be illuminated, creating a great light effect.

We can choose single color or combine finishes:

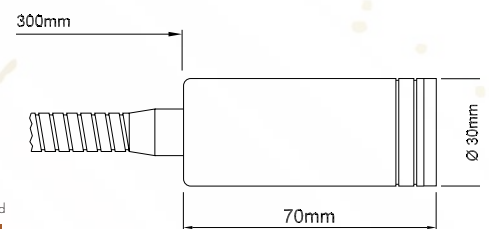

ROUND

Flex Lamp collection



REFERENCE: FDF01901-1-2

This reading lamp is like a built-in mechanism, so you can install it in a standard built-in box next to the headboard. You can move it, to direct the light when you need it. It incorporates a 2.6W direct Bi-Pin G9 LED LAMP at 230V and a color temperature of 2700°K, to create a cozy atmosphere. It also includes a matt glass to maintain a good uniformity in the object to be illuminated, creating a great light effect.

We can choose single color or combine finishes:

SMN
Satin Matt Nickel



SMP
Soft Matt Patinated



SMG
Satin Matt Gold



WH
White



BK
Black



OB
Bright Gold



CB
Bright Chrome



CM
Matt Chrome



PB
Bright Patinated



PM
Matt Patinated

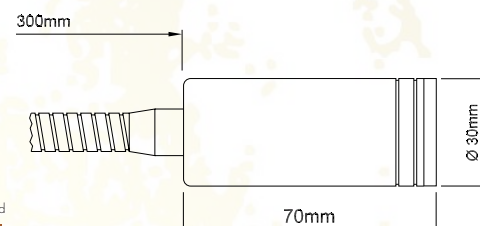

ROUND

Flex Lamp collection



REFERENCE: FDF01901-1-2

This reading lamp is like a built-in mechanism, so you can install it in a standard built-in box next to the headboard. You can move it, to direct the light when you need it. It incorporates a 2.6W direct Bi-Pin G9 LED LAMP at 230V and a color temperature of 2700°K, to create a cozy atmosphere. It also includes a matt glass to maintain a good uniformity in the object to be illuminated, creating a great light effect.

We can choose single color or combine finishes:

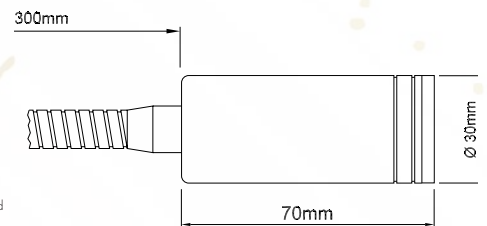

ROUND

Flex Lamp collection



REFERENCE: FDF01901-1-2

This reading lamp is like a built-in mechanism, so you can install it in a standard built-in box next to the headboard. You can move it, to direct the light when you need it. It incorporates a 2.6W direct Bi-Pin G9 LED LAMP at 230V and a color temperature of 2700°K, to create a cozy atmosphere. It also includes a matt glass to maintain a good uniformity in the object to be illuminated, creating a great light effect.

We can choose single color or combine finishes:

SMN
Satin Matt Nickel



SMP
Soft Matt Patinated



SMG
Satin Matt Gold



WH



BK



OB



CB



CM



PB



PM

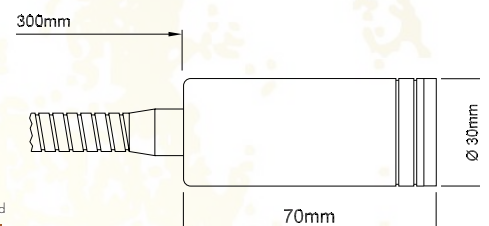

STUDIO

Flex Lamp collection



STUDIO

Flex Lamp collection



REFERENCE: **FDFO1801-1-2**

This reading lamp is like a built-in mechanism, so you can install it in a standard built-in box next to the headboard. You can move it, to direct the light when you need it. It incorporates a 2.6W direct Bi-Pin G9 LED LAMP at 230V and a color temperature of 2700°K, to create a cozy atmosphere. It also includes a matt glass to maintain a good uniformity in the object to be illuminated, creating a great light effect.

We can choose single color or combine finishes:

SMN
Satin Matt Nickel



SMP
Soft Matt Patinated



SMG
Satin Matt Gold



WH

White



BK

Black



OB

Bright Gold



CB

Bright Chrome



CM

Matt Chrome



PB

Bright Patinated



PM

Matt Patinated



300mm

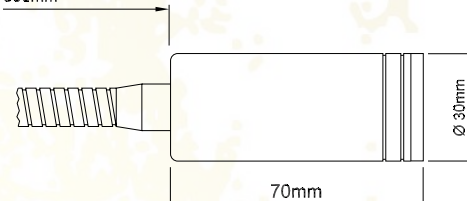

STUDIO

Flex Lamp collection

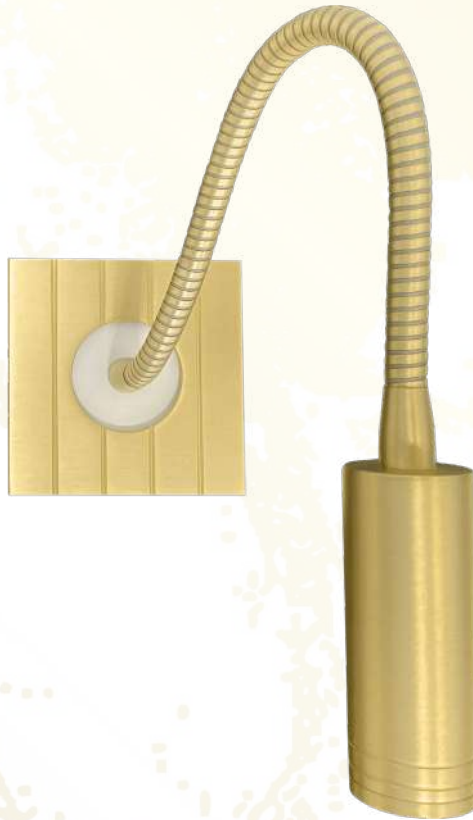

REFERENCE: FDF01801-1-2

This reading lamp is like a built-in mechanism, so you can install it in a standard built-in box next to the headboard. You can move it, to direct the light when you need it. It incorporates a 2.6W direct Bi-Pin G9 LED LAMP at 230V and a color temperature of 2700°K, to create a cozy atmosphere. It also includes a matt glass to maintain a good uniformity in the object to be illuminated, creating a great light effect.

We can choose single color or combine finishes:

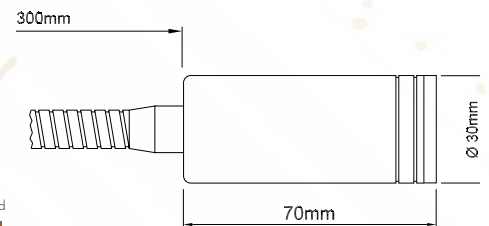
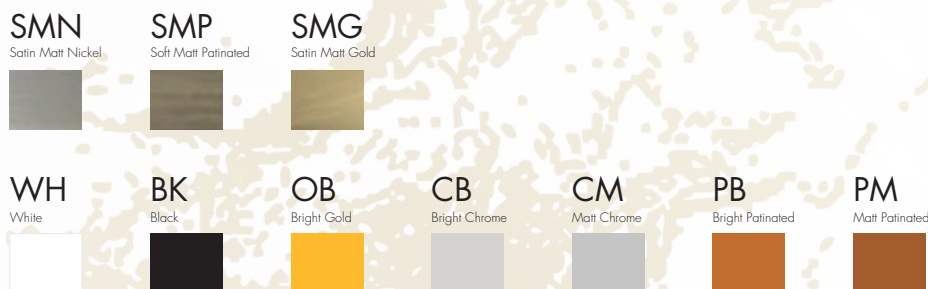

STUDIO

Flex Lamp collection



REFERENCE: FDF01801-1-2

This reading lamp is like a built-in mechanism, so you can install it in a standard built-in box next to the headboard. You can move it, to direct the light when you need it. It incorporates a 2.6W direct Bi-Pin G9 LED LAMP at 230V and a color temperature of 2700°K, to create a cozy atmosphere. It also includes a matt glass to maintain a good uniformity in the object to be illuminated, creating a great light effect.

We can choose single color or combine finishes:

SMN
Satin Matt Nickel



SMP
Soft Matt Patinated



SMG
Satin Matt Gold



WH

White



BK

Black



OB

Bright Gold



CB

Bright Chrome



CM

Matt Chrome



PB

Bright Patinated



PM

Matt Patinated



300mm

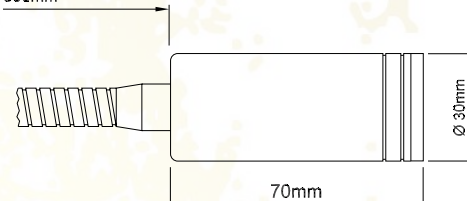

STUDIO

Flex Lamp collection



REFERENCE: **DFD01801-1-3**

This reading lamp is like a built-in mechanism, so you can install it in a standard built-in box next to the headboard. You can move it, to direct the light when you need it. It incorporates a 2.6W direct Bi-Pin G9 LED LAMP at 230V and a color temperature of 2700°K, to create a cozy atmosphere. It also includes a matt glass to maintain a good uniformity in the object to be illuminated, creating a great light effect.

We can choose single color or combine finishes:

SMN

Satin Matt Nickel



SMP

Soft Matt Patinated



SMG

Satin Matt Gold



WH

White



BK

Black



OB

Bright Gold



CB

Bright Chrome



CM

Matt Chrome



PB

Bright Patinated



PM

Matt Patinated



300mm

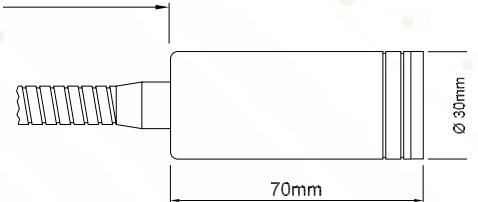

STUDIO

Flex Lamp collection



REFERENCE: FDF01801-1-2

This reading lamp is like a built-in mechanism, so you can install it in a standard built-in box next to the headboard. You can move it, to direct the light when you need it. It incorporates a 2.6W direct Bi-Pin G9 LED LAMP at 230V and a color temperature of 2700°K, to create a cozy atmosphere. It also includes a matt glass to maintain a good uniformity in the object to be illuminated, creating a great light effect.

We can choose single color or combine finishes:

SMN
Satin Matt Nickel



SMP
Soft Matt Patinated



SMG
Satin Matt Gold



WH
White



BK
Black



OB
Bright Gold



CB
Bright Chrome



CM
Matt Chrome



PB
Bright Patinated



PM
Matt Patinated

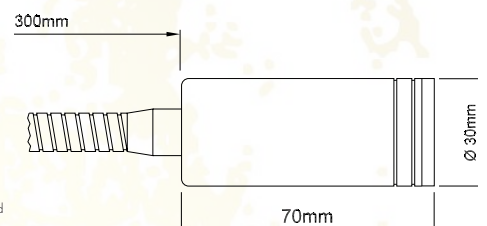

STUDIO

Flex Lamp collection



REFERENCE: FDF01801-1-2

This reading lamp is like a built-in mechanism, so you can install it in a standard built-in box next to the headboard. You can move it, to direct the light when you need it. It incorporates a 2.6W direct Bi-Pin G9 LED LAMP at 230V and a color temperature of 2700°K, to create a cozy atmosphere. It also includes a matt glass to maintain a good uniformity in the object to be illuminated, creating a great light effect.

We can choose single color or combine finishes:

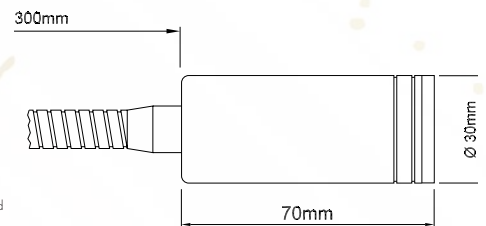
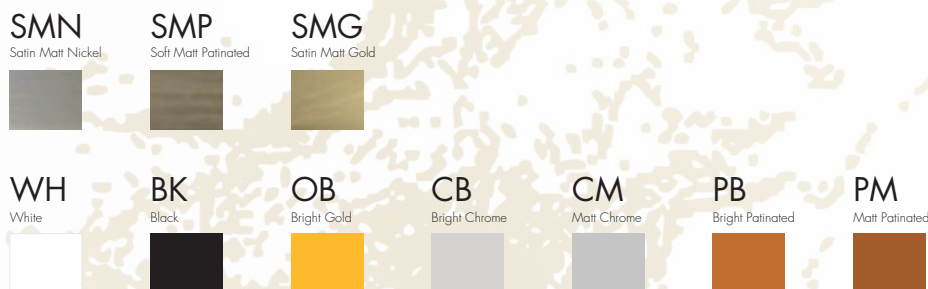

STUDIO

Flex Lamp collection



REFERENCE: FDF01801-1-2

This reading lamp is like a built-in mechanism, so you can install it in a standard built-in box next to the headboard. You can move it, to direct the light when you need it. It incorporates a 2.6W direct Bi-Pin G9 LED LAMP at 230V and a color temperature of 2700°K, to create a cozy atmosphere. It also includes a matt glass to maintain a good uniformity in the object to be illuminated, creating a great light effect.

We can choose single color or combine finishes:

SMN
Satin Matt Nickel



SMP
Soft Matt Patinated



SMG
Satin Matt Gold



WH

White



BK

Black



OB

Bright Gold



CB

Bright Chrome



CM

Matt Chrome



PB

Bright Patinated



PM

Matt Patinated



300mm

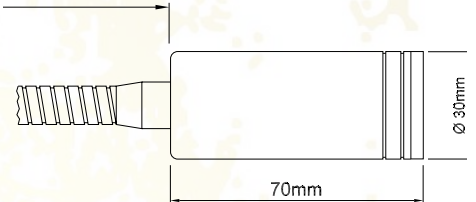



ROUND

Reading Lamp collection



ROUND

Reading Lamp collection



REFERENCE: FDF01901-2-2

This reading lamp is like a built-in mechanism, so you can install it in a standard built-in box next to the headboard. You can move it, to direct the light when you need it. It incorporates a 2.6W direct Bi-Pin G9 LED LAMP at 230V and a color temperature of 2700°K, to create a cozy atmosphere. It also includes a matt glass to maintain a good uniformity in the object to be illuminated, creating a great light effect.

We can choose single color or combine finishes:

SMN
Satin Matt Nickel



SMP
Soft Matt Patinated



SMG
Satin Matt Gold



WH
White



BK
Black



OB
Bright Gold



CB
Bright Chrome



CM
Matt Chrome



PB
Bright Patinated



PM
Matt Patinated

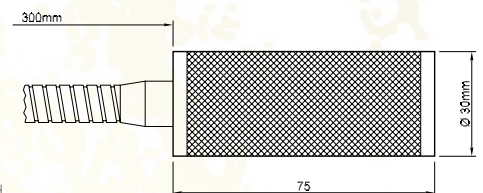

TWENTY

Reading Lamp collection



TWENTY

Reading Lamp collection



REFERENCE: FDF02001-2-2

This reading lamp is like a built-in mechanism, so you can install it in a standard built-in box next to the headboard. You can move it, to direct the light when you need it. So, it is adjustable and tilt, with the option to have a handle. (vs. -H) It incorporates a 2.6W direct Bi-Pin G9 LED LAMP at 230V and a color temperature of 2700°K, to create a cozy atmosphere. It also includes a matt glass to maintain a good uniformity in the object to be illuminated, creating a great light effect.

We can choose single color or combine finishes:

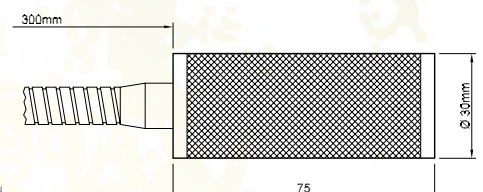



TULIPA

Wall Light collection



TULIPA

Wall Light collection



REFERENCE: FDF1197A-1-2

This reading lamp is like a built-in mechanism, so you can install it in a standard built-in box next to the headboard. You can move it, to direct the light when you need it. It incorporates a 2.6W direct Bi-Pin G9 LED LAMP at 230V and a color temperature of 2700°K, to create a cozy atmosphere. Available with pull cord switch or toggle switch.

We can choose single color or combine finishes:

SMN

Satin Matt Nickel



SMP

Soft Matt Patinated



SMG

Satin Matt Gold



WH

White



BK

Black



OB

Bright Gold



CB

Bright Chrome



CM

Matt Chrome



PB

Bright Patinated



PM

Matt Patinated

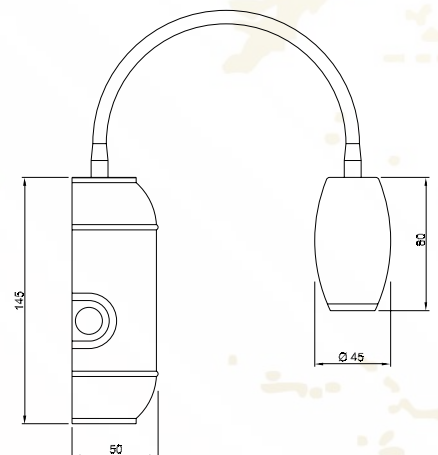

TULIPA

Wall Light collection



REFERENCE: FDF1197B-2-2

This reading lamp is like a built-in mechanism, so you can install it in a standard built-in box next to the headboard. You can move it, to direct the light when you need it. It incorporates a 5W direct GU10 LED LAMP at 230V and a color temperature of 2700°K, to create a cozy atmosphere. Available with pull cord switch or toggle switch.

We can choose single color or combine finishes:

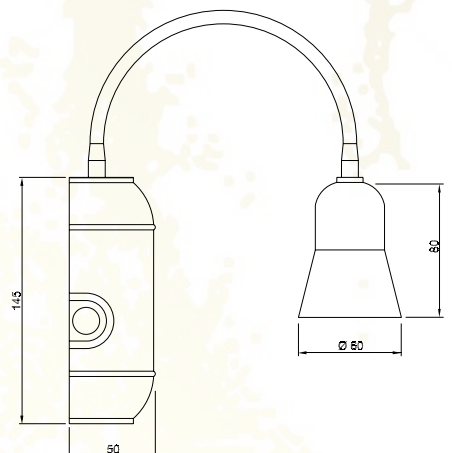

Technical Data

Flex Lamp collection

Description

Reading lamp with 30 cm flex, for LED lamp Bi-Pin 1,7W with G4 lampholder and 12V Electronic Transformer incorporated.

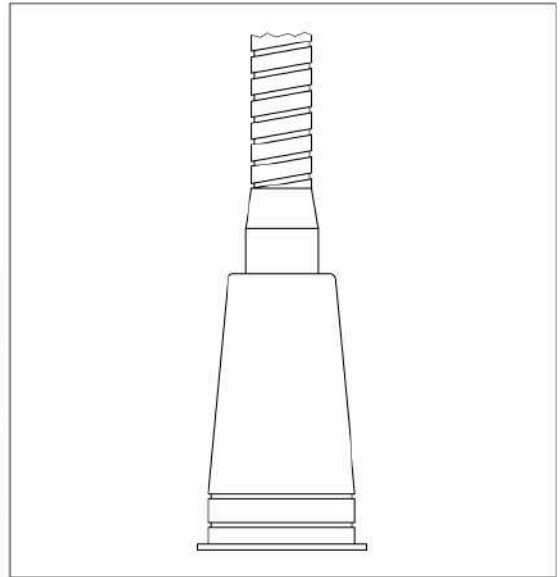
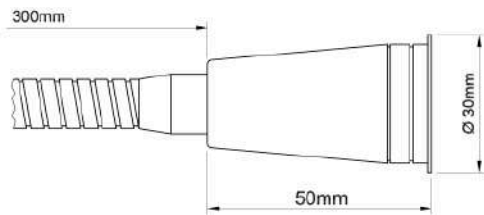

Finished

FDF02001-1-1XX

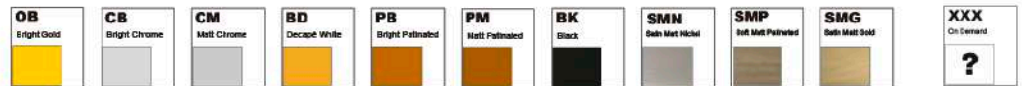

FDF02001-1-1XX

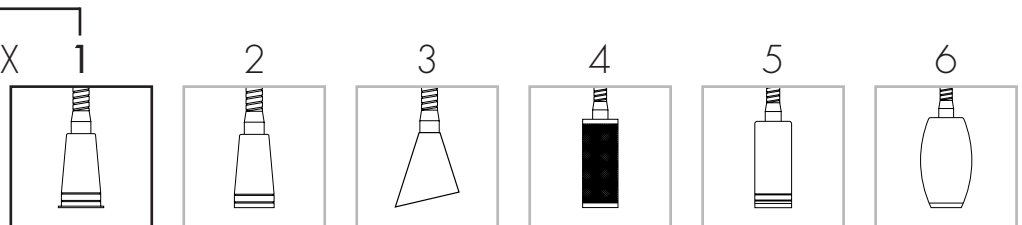

Technical Data

Lamp type: LED Bi-Pin 12Va
Power: 1,7W
Lampholder: G4
Colour Temperature : 3000°K
Illuminance : 205Lm



Type of Transformer: Encapsulated
Power : Maximum 70W
Electric Tension : 230V / 11.5Vac

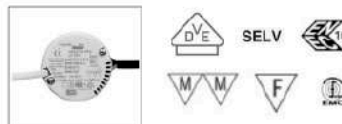

Connection Take: Plug and Play
Intensity : max. 20A
Electric Tension : max. 300V



Type Switch : Toggle
Intensity : max. 2A



Technical Data

Flex Lamp collection

Description

Reading lamp with 30 cm flex, for LED lamp Bi-Pin 1,7W with G4 lampholder and 12V Electronic Transformer incorporated.

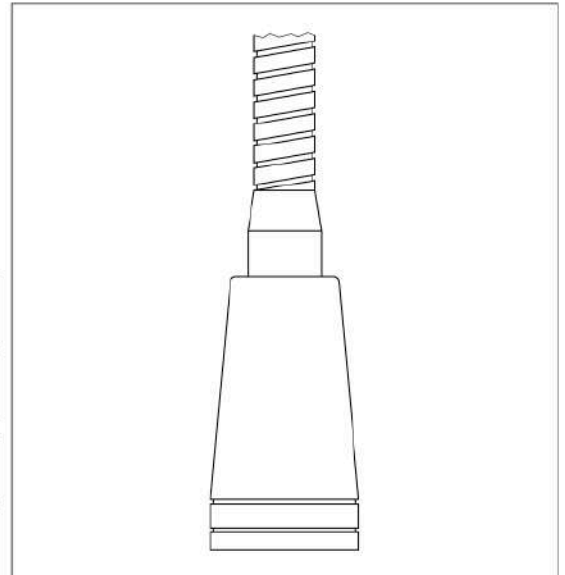
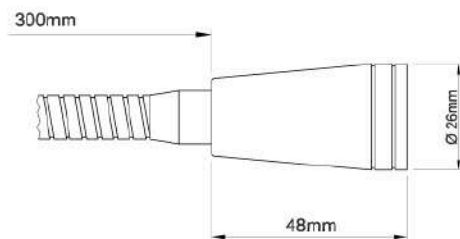

Finished

FDF02001-1-1XX

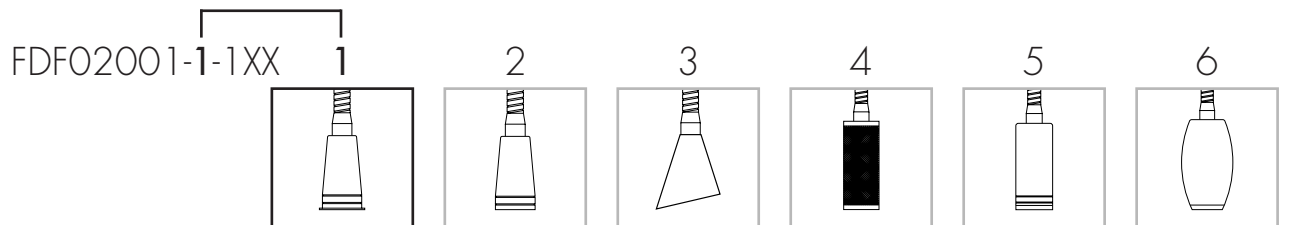

Technical Data

Lamp type: LED Bi-Pin 12Va
Power: 1,7W
Lampholder: G4
Colour Temperature : 3000°K
Illuminance : 205Lm



Type of Transformer: Encapsulated
Power : Maximum 70W
Electric Tension : 230V / 11.5Vac

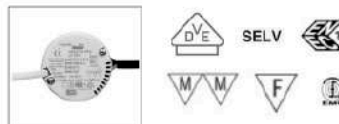

Connection Take: Plug and Play
Intensity : max. 20A
Electric Tension : max. 300V



Type Switch : Toggle
Intensity : max. 2A



Technical Data

Flex Lamp collection

Description

Reading lamp with 30 cm flex, for LED lamp Bi-Pin 1,7W with G4 lampholder and 12V Electronic Transformer incorporated.

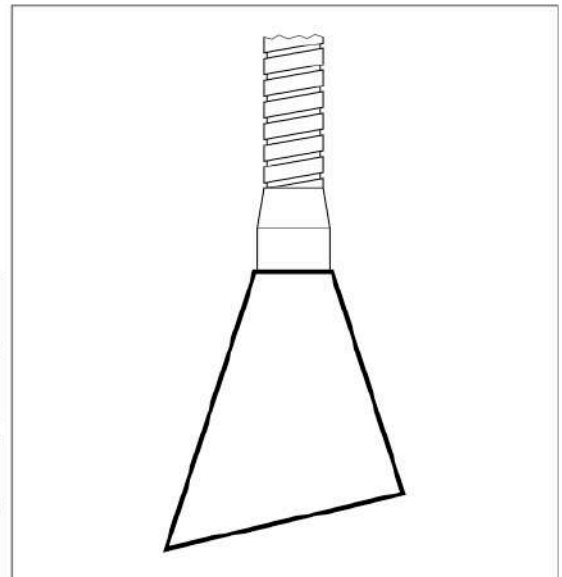
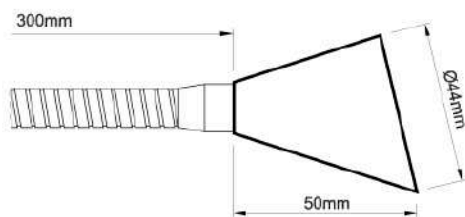

Finished

FDF02001-1-1XX



FDF02001-1-1XX

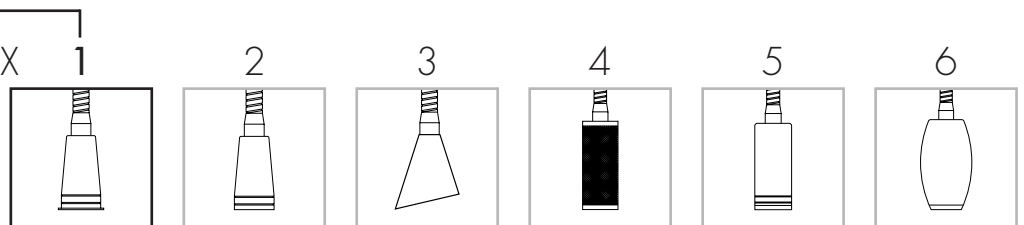

Technical Data

Lamp type: LED Bi-Pin 12Va
Power: 1,7W
Lampholder: G4
Colour Temperature : 3000°K
Illuminance : 205Lm

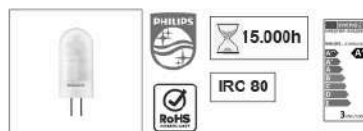

Type of Transformer: Encapsulated
Power : Maximum 70W
Electric Tension : 230V / 11.5Vac

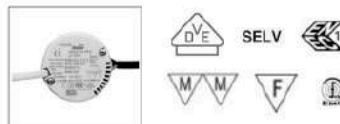

Connection Take: Plug and Play
Intensity : max. 20A
Electric Tension : max. 300V



Type Switch : Toggle
Intensity : max. 2A



Technical Data

Flex Lamp collection

Description

Reading lamp with 30 cm flex, for LED lamp Bi-Pin 2,6W with G9 lampholder direct to 230V.

Decorative ring with protection glass.

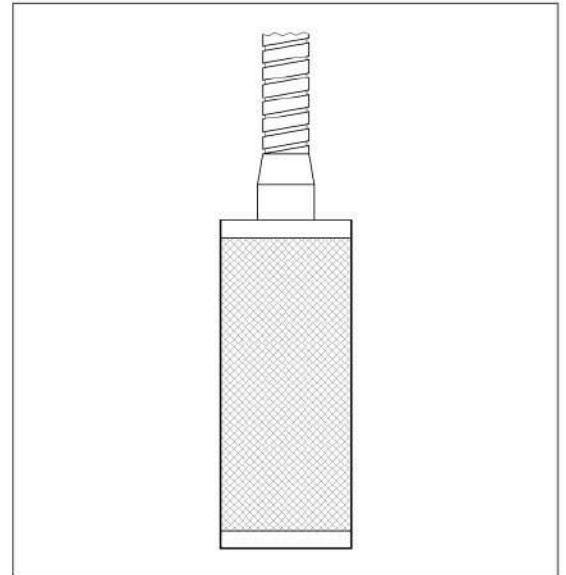
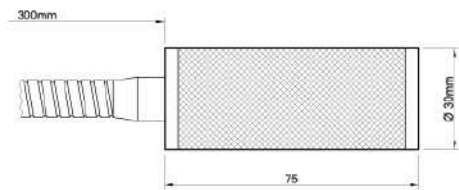

Finished

FDF02001-1-1XX

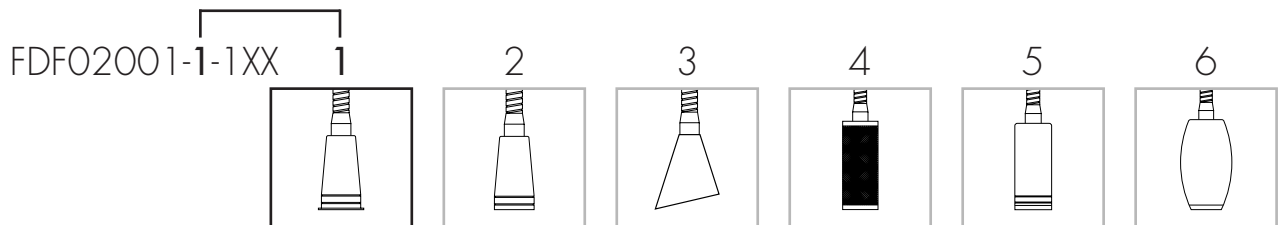

Technical Data

Lamp type: LED Bi-Pin 230V
Power: 2,6W
Lampholder: G9
Colour Temperature : 2700°K
Illuminance : 320Lm



Connection Take: Plug and Play
Intensity : max. 20A
Electric Tension : max. 300V



Type Switch : Toggle
Intensity : max. 2A

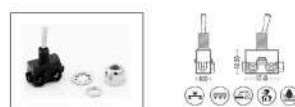

Technical Data

Flex Lamp collection

Description

Reading lamp with 30 cm flex, for LED lamp Bi-Pin 2,6W with G9 lampholder direct to 230V.

Decorative ring with protection glass.

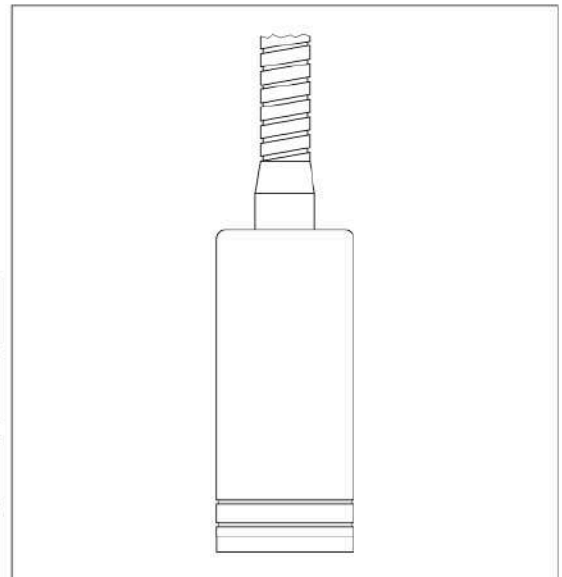
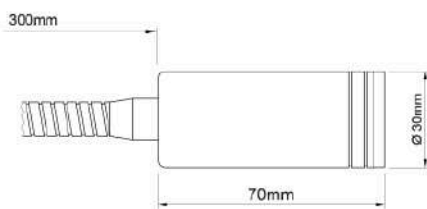

Finished

FDF02001-1-1XX



FDF02001-1-1XX

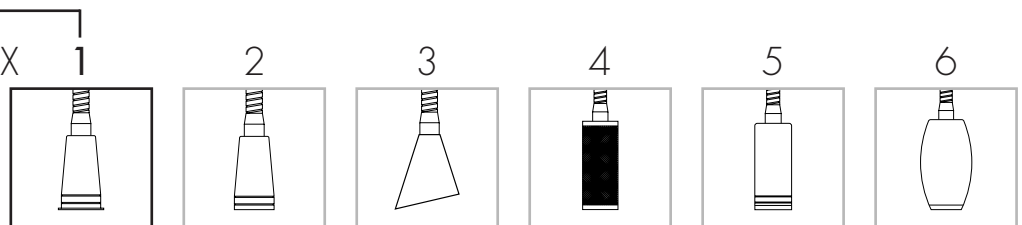

Technical Data

Lamp type: LED Bi-Pin 230V
Power: 2,6W
Lampholder: G9
Colour Temperature : 2700°K
Illuminance : 320Lm



Connection Take: Plug and Play
Intensity : max. 20A
Electric Tension : max. 300V



Type Switch : Toggle
Intensity : max. 2A



Technical Data

Flex Lamp collection

Description

Reading lamp with 30 cm flex, for LED lamp Bi-Pin 2,6W with G9 lampholder direct to 230V.

Decorative ring with protection glass.

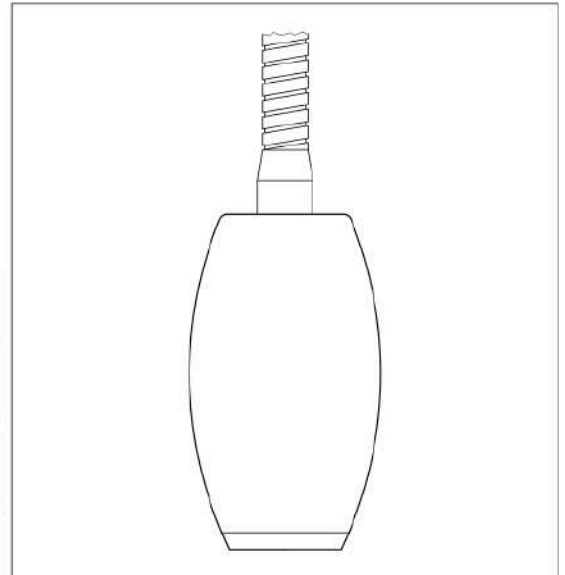
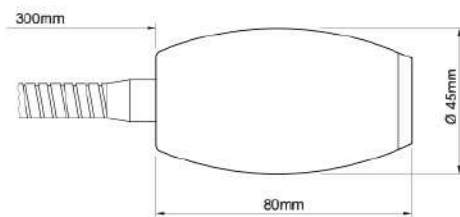

Finished

FDF02001-1-1XX

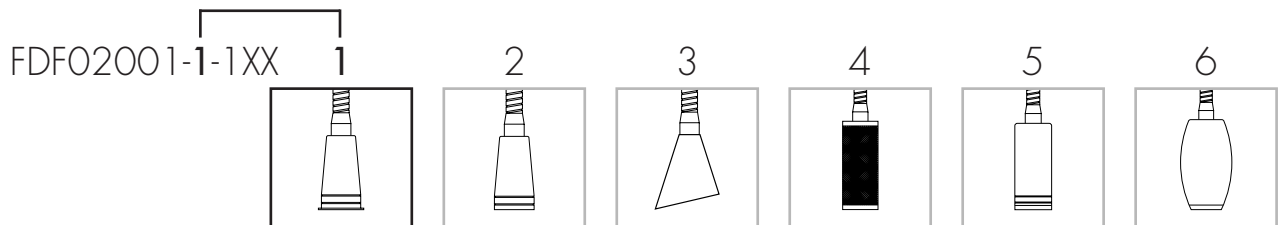

Technical Data

Lamp type: LED Bi-Pin 230V
Power: 2,6W
Lampholder: G9
Colour Temperature : 2700°K
Illuminance : 320Lm



Connection Take: Plug and Play
Intensity : max. 20A
Electric Tension : max. 300V



Type Switch : Toggle
Intensity : max. 2A





HEADQUARTERS & SHOWROOM

Av. Llenguadoc, 45-47 · (08915) Badalona · (Barcelona) SPAIN · Phone +34 934 183 856 · info@fedeswitchandlight.com

www.fedeswitchandlight.com

C2020 #002